

swissbit®

Preliminary
Product Data Sheet

FIDO2 Hardware Authenticator

iShield Key 2 Series
USB-A / C with NFC

Date: April 10, 2025
Revision: 1.00



 Made in Germany

Contents

1.	PRODUCT SUMMARY	3
2.	PRODUCT FEATURES	4
3.	ORDERING INFORMATION	4
4.	PRODUCT DESCRIPTION	15
	4.1 CURRENT CONSUMPTION	16
	4.2 ENVIRONMENTAL SPECIFICATIONS	17
	4.3 REGULATORY COMPLIANCE	18
	4.4 MECHANICAL SPECIFICATIONS	18
	4.5 RELIABILITY	18
5.	ELECTRICAL INTERFACE	20
6.	ELECTRICAL SPECIFICATION	21
7.	PACKAGE MECHANICAL	22
8.	FUNCTIONALITY	23
9.	FEATURES	23
10.	PART NUMBER DECODER	24
11.	MARKING SPECIFICATION	25
12.	REVISION HISTORY	26

iShield Key Series USB-A / NFC

1. Product Summary

Mechanical Details	Form Factor / Device Type
USB-A: 65 x 16,0 x 5,2 mm, 5g USB-C: 60 x 16,0 x 5,2 mm, 5g Housing Color: RAL 9005 (Black) Rear Touch sensor, keychain hole Water resistant, robust construction IP68	CCID Smartcard, FIDO2 HID Device USB-A/C Device with NFC interface Multi-color RGB LED w/ Dual-Side illumination
Temperature Range	Certifications
Operational: -25 °C to 70 °C Storage: -25 °C to 85 °C	FIDO2/CTAP2.1 Level 1 Certified Universal 2nd Factor (U2F) CTAP1 Certified Microsoft Certified
Platforms Supported	
Operating Systems: Browsers:	Windows 10/11, MacOS, iOS, iPadOS, Linux, Chrome, Android Firefox, MS Edge, Chrome, Apple Safari
Features	
Chip: Chip OS: Flash Memory: Certifications: Algorithms:	NXP P71D600 JCOP 4.5 600 KB FIPS140-3 L3: Cryptographic Module Validation Program CSRC (nist.gov) Common Criteria EAL6+: https://www.commoncriteriaportal.org/files/epfiles/NSCIB-CC-2300127-01_CR.pdf RSA: 2048, 3072, 4096 ECDSA: 224, 256, 384, 512 AES: 128, 192, 256 HMAC: SHA1, SHA2-256, -384, -512
Optional Features	
Options	MIFARE DESFire EV3, HID SEOS, LEGIC advant/neon, Enterprise Attestation
Shipping Information	
Options	CSV file containing production batch, smart card model, manufacturing batch, serial numbers
Compliance	
CE, FCC, UKCA, RoHS, WEEE, REACH, FDA, TAA, MIL-STD810H, MIL STD-1009, JESD22-A104, JESD22-A104, JESD22-A103, JESD22-A108, AEC Q100-008, JESD22-A102D, IEC 60068-2-11, IEC 60068-2-27, JESD22-B110, IEC 60068-2-6, JESD22-A108, IEC 61000-4-2, DIN ISO 9022-9	

2. Product Features

Technology & Features



Digital Authentication

- Compatibility with hundreds of services (Google, Microsoft, AWS etc.)
- Multi-Protocol Support:
 - FIDO2 (passwordless login, phishing protection)
 - Storage of up to 300 passkeys
 - HOTP & TOTP (One-Time Passwords)
 - PIV (smartcard functionality)

Access Control

- MIFARE (offers additional features such as payment, membership cards or digital tickets)
- Optional: HID SEOS, LEGIC advant/neon

Certifications

- FIDO2-certified
- FIPS140-3 Level 3
- OpenSC compatibility
- Enterprise Attestation (optional)



Feature	iShield Key 2 FIDO2	iShield Key 2 Pro	iShield Key 2 FIDO2 MIFARE	iShield Key 2 Pro MIFARE	iShield Key 2 FIDO2 FIPS	iShield Key 2 Pro FIPS
FIDO2	✓	✓	✓	✓	✓	✓
PIV (Smartcard)		✓		✓		✓
OTP (HOTP, TOTP)		✓		✓		✓
300 Passkeys	✓	✓	✓	✓	✓	✓
MIFARE			✓	✓		
FIPS					✓	✓



3. Ordering Information

Table 1: Standard Product List

Product Type	Product Series	Part Number	Supported Standards / Features
	iShield Key 2 FIDO2	PK2000IA0000E-2002-1AA-SBT <i>(Delivery in tray)</i>	WebAuthn, FIDO2/CTAP2 Universal 2nd Factor (U2F) CTAP1
		PK2000IA0000E-2002-1AA-SBB <i>(Delivery in single packaging)</i>	
	iShield Key 2 Pro	PK2000IA0000E-2002-1BA-SBT <i>(Delivery in tray)</i>	WebAuthn, FIDO2/CTAP2 Universal 2nd Factor (U2F) CTAP1



			PK2000IA0000E-2002-1BA-SBB <i>(Delivery in single packaging)</i>	HOTP (Event) TOTP (Time) Smartcard (PIV-compatible) OpenSC-compatible
---	--	--	---	--



	USB-C NFC	iShield Key 2 FIDO2	PK2000IC0000E-1002-1DA-SBT <i>(Delivery in tray)</i>	WebAuthn, FIDO2/CTAP2 Universal 2nd Factor (U2F) CTAP1
			PK2000IC0000E-1002-1DA-SBB <i>(Delivery in single packaging)</i>	
	USB-C NFC	iShield Key 2 Pro	PK2000IC0000E-2002-1BA-SBT <i>(Delivery in tray)</i>	WebAuthn, FIDO2/CTAP2 Universal 2nd Factor (U2F) CTAP1 HOTP (Event) TOTP (Time) Smartcard (PIV-compatible) OpenSC-compatible
			PK2000IC0000E-2002-1BA-SBB <i>(Delivery in single packaging)</i>	

Product Type	Product Series	Part Number	Supported Standards / Features	
	USB-A NFC	iShield Key 2 FIDO2 MIFARE	PK2000IA0000E-2002-1AB-SBT <i>(Delivery in tray)</i>	WebAuthn, FIDO2/CTAP2 Universal 2nd Factor (U2F) CTAP1 MIFARE DESFire EV3
			PK2000IA0000E-2002-1AB-SBB <i>(Delivery in single packaging)</i>	
	USB-A NFC	iShield Key 2 Pro MIFARE	PK2000IA0000E-2002-1BB-SBT <i>(Delivery in tray)</i>	WebAuthn, FIDO2/CTAP2 Universal 2nd Factor (U2F) CTAP1 HOTP (Event) TOTP (Time) Smartcard (PIV-compatible) OpenSC-compatible MIFARE DESFire EV3
			PK2000IA0000E-2002-1BB-SBB <i>(Delivery in single packaging)</i>	





	USB-C NFC	iShield Key 2 FIDO2 MIFARE	PK2000IC0000E-2002-1AB-SBT <i>(Delivery in tray)</i>	WebAuthn, FIDO2/CTAP2 Universal 2nd Factor (U2F) CTAP1 MIFARE DESFire EV3
			PK2000IC0000E-2002-1AB-SBB <i>(Delivery in single packaging)</i>	
	USB-C NFC	iShield Key 2 Pro MIFARE	PK2000IC0000E-2002-1BB-SBT	WebAuthn, FIDO2/CTAP2 Universal 2nd Factor (U2F) CTAP1



			<i>(Delivery in tray)</i>	HOTP (Event) TOTP (Time) Smartcard (PIV-compatible) OpenSC-compatible MIFARE DESFire EV3
			PK2000IC0000E-2002-1BB-SBB <i>(Delivery in single packaging)</i>	



Product Type	Product Series	Part Number	Supported Standards / Features
	USB-A NFC iShield Key 2 FIDO2 FIPS	PK2000IA0000E-2002-1DA-SBT <i>(Delivery in tray)</i>	WebAuthn, FIDO2/CTAP2 Universal 2nd Factor (U2F) CTAP1 FIPS140-3 Level 3
		PK2000IA0000E-2002-1DA-SBB <i>(Delivery in single packaging)</i>	
	USB-A NFC iShield Key 2 Pro FIPS	PK2000IA0000E-2002-1CA-SBT <i>(Delivery in tray)</i>	WebAuthn, FIDO2/CTAP2 Universal 2nd Factor (U2F) CTAP1 HOTP (Event) TOTP (Time) Smartcard (PIV-compatible) OpenSC-compatible FIPS140-3 Level 3
		PK2000IA0000E-2002-1CA-SBB <i>(Delivery in single packaging)</i>	



	USB-C NFC iShield Key 2 FIDO2 FIPS	PK2000IC0000E-2002-1DA-SBT <i>(Delivery in tray)</i>	WebAuthn, FIDO2/CTAP2 Universal 2nd Factor (U2F) CTAP1 FIPS140-3 Level 3
		PK2000IC0000E-2002-1DA-SBB <i>(Delivery in single packaging)</i>	
	USB-C NFC iShield Key 2 Pro FIPS	PK2000IC0000E-2002-1CA-SBT <i>(Delivery in tray)</i>	WebAuthn, FIDO2/CTAP2 Universal 2nd Factor (U2F) CTAP1 HOTP (Event) TOTP (Time) Smartcard (PIV-compatible) OpenSC-compatible FIPS140-3 Level 3
		PK2000IC0000E-2002-1CA-SBB <i>(Delivery in single packaging)</i>	



Product Type	Product Series	Part Number	Supported Standards / Features
USB-A NFC	iShield Key 2 FIDO2 HID	PK2000IA0000E-2002-1AD-SBT <i>(Delivery in tray)</i>	WebAuthn, FIDO2/CTAP2 Universal 2nd Factor (U2F) CTAP1 HID SEOS



			PK2000IA0000E-2002-1AD-SBB <i>(Delivery in single packaging)</i>	
	USB-A NFC	iShield Key 2 Pro HID	PK2000IA0000E-2002-1BD-SBB <i>(Delivery in tray)</i>	WebAuthn, FIDO2/CTAP2 Universal 2nd Factor (U2F) CTAP1 HOTP (Event) TOTP (Time) Smartcard (PIV-compatible) OpenSC-compatible HID SEOS
			PK2000IA0000E-2002-1BD-SBT <i>(Delivery in single packaging)</i>	
	USB-C NFC	iShield Key 2 FIDO2 HID	PK2000IC0000E-2002-1AD-SBT <i>(Delivery in tray)</i>	WebAuthn, FIDO2/CTAP2 Universal 2nd Factor (U2F) CTAP1 HID SEOS
			PK2000IC0000E-2002-1AD-SBB <i>(Delivery in single packaging)</i>	
	USB-C NFC	iShield Key 2 Pro HID	PK2000IC0000E-2002-1BD-SBT <i>(Delivery in tray)</i>	WebAuthn, FIDO2/CTAP2 Universal 2nd Factor (U2F) CTAP1 HOTP (Event) TOTP (Time) Smartcard (PIV-compatible) OpenSC-compatible HID SEOS
			PK2000IC0000E-2002-1BD-SBB <i>(Delivery in single packaging)</i>	



Product Type	Product Series	Part Number	Supported Standards / Features
	USB-A NFC	iShield Key 2 FIDO2 FIPS HID	WebAuthn, FIDO2/CTAP1 Universal 2nd Factor (U2F) CTAP1 FIPS140-3 Level 3 HID SEOS
		PK2000IA0000E-2002-1DD-SBT <i>(Delivery in tray)</i>	
	USB-A NFC	iShield Key 2 Pro FIPS HID	WebAuthn, FIDO2/CTAP2 Universal 2nd Factor (U2F) CTAP1 HOTP (Event) TOTP (Time) Smartcard (PIV-compatible) OpenSC-compatible FIPS140-3 Level 3 HID SEOS
		PK2000IA0000E-2002-1DD-SBB <i>(Delivery in single packaging)</i>	

	USB-C NFC	iShield Key 2 FIDO2 FIPS HID	WebAuthn, FIDO2/CTAP2 Universal 2nd Factor (U2F) CTAP1 FIPS140-3 Level 3 HID SEOS
		PK2000IC0000E-2002-1DD-SBT <i>(Delivery in tray)</i>	
	USB-C NFC	iShield Key 2 Pro FIPS HID	WebAuthn, FIDO2/CTAP2 Universal 2nd Factor (U2F) CTAP1 HOTP (Event) TOTP (Time) Smartcard (PIV-compatible) OpenSC-compatible FIPS140-3 Level 3 HID SEOS
		PK2000IC0000E-2002-1CD-SBT <i>(Delivery in tray)</i>	
		iShield Key 2 Pro FIPS HID	WebAuthn, FIDO2/CTAP2 Universal 2nd Factor (U2F) CTAP1 HOTP (Event) TOTP (Time) Smartcard (PIV-compatible) OpenSC-compatible FIPS140-3 Level 3 HID SEOS
		PK2000IC0000E-2002-1CD-SBB <i>(Delivery in single packaging)</i>	



Product Type	Product Series	Part Number	Supported Standards / Features
	USB-A NFC	iShield Key 2 FIDO2 LEGIC	WebAuthn, FIDO2/CTAP2 Universal 2nd Factor (U2F) CTAP1 LEGIC advant/neon
		PK2000IA0000E-2002-1AC-SBT <i>(Delivery in tray)</i>	
	USB-A NFC	iShield Key 2 Pro LEGIC	WebAuthn, FIDO2/CTAP2 Universal 2nd Factor (U2F) CTAP1 HOTP (Event) TOTP (Time) Smartcard (PIV-compatible) OpenSC-compatible LEGIC advant/neon
		PK2000IA0000E-2002-1BC-SBB <i>(Delivery in tray)</i>	
		iShield Key 2 Pro LEGIC	WebAuthn, FIDO2/CTAP2 Universal 2nd Factor (U2F) CTAP1 HOTP (Event) TOTP (Time) Smartcard (PIV-compatible) OpenSC-compatible LEGIC advant/neon
		PK2000IA0000E-2002-1BC-SBT <i>(Delivery in single packaging)</i>	



	USB-C NFC	iShield Key 2 FIDO2 LEGIC	PK2000IC0000E-2002-1AC-SBT <i>(Delivery in tray)</i>	WebAuthn, FIDO2/CTAP2 Universal 2nd Factor (U2F) CTAP1 LEGIC advant/neon
			PK2000IC0000E-2002-1AC-SBB <i>(Delivery in single packaging)</i>	
	USB-C NFC	iShield Key 2 Pro LEGIC	PK2000IC0000E-2002-1BC-SBT <i>(Delivery in tray)</i>	WebAuthn, FIDO2/CTAP2 Universal 2nd Factor (U2F) CTAP1 HOTP (Event) TOTP (Time) Smartcard (PIV-compatible) OpenSC-compatible LEGIC advant/neon
			PK2000IC0000E-2002-1BC-SBB <i>(Delivery in single packaging)</i>	



Product Type	Product Series	Part Number	Supported Standards / Features	
	USB-A NFC	iShield Key 2 FIDO2 FIPS LEGIC	PK2000IA0000E-2002-1DC-SBT <i>(Delivery in tray)</i>	WebAuthn, FIDO2/CTAP2 Universal 2nd Factor (U2F) CTAP1 FIPS140-3 Level 3 LEGIC advant/neon
			PK2000IA0000E-2002-1DC-SBB <i>(Delivery in single packaging)</i>	
	USB-A NFC	iShield Key 2 Pro FIPS LEGIC	PK2000IA0000E-2002-1CC-SBT <i>(Delivery in tray)</i>	WebAuthn, FIDO2/CTAP2 Universal 2nd Factor (U2F) CTAP1 HOTP (Event) TOTP (Time) Smartcard (PIV-compatible) OpenSC-compatible FIPS140-3 Level 3 LEGIC advant/neon
			PK2000IA0000E-2002-1CC-SBB <i>(Delivery in single packaging)</i>	

	USB-C NFC	iShield Key 2 FIDO2 FIPS LEGIC	PK2000IC0000E-2002-1DC-SBT <i>(Delivery in tray)</i>	WebAuthn, FIDO2/CTAP2 Universal 2nd Factor (U2F) CTAP1 FIPS140-3 Level 3 LEGIC advant/neon
			PK2000IC0000E-2002-1DC-SBB <i>(Delivery in single packaging)</i>	
	USB-C NFC	iShield Key 2 Pro FIPS LEGIC	PK2000IC0000E-2002-1CC-SBT <i>(Delivery in tray)</i>	WebAuthn, FIDO2/CTAP2 Universal 2nd Factor (U2F) CTAP1 HOTP (Event) TOTP (Time) Smartcard (PIV-compatible) OpenSC-compatible FIPS140-3 Level 3 LEGIC advant/neon
			PK2000IC0000E-2002-1CC-SBB <i>(Delivery in single packaging)</i>	

Enterprise

Product Type	Product Series	Part Number	Supported Standards / Features
	iShield Key 2 FIDO2 Enterprise	PK2000IA0000E-2002-2AA-SBT <i>(Delivery in tray)</i>	WebAuthn, FIDO2/CTAP2 Universal 2nd Factor (U2F) CTAP1 Enterprise
		PK2000IA0000E-2002-2AA-SBB <i>(Delivery in single packaging)</i>	
	iShield Key 2 Pro Enterprise	PK2000IA0000E-2002-2BA-SBT <i>(Delivery in tray)</i>	WebAuthn, FIDO2/CTAP2 Universal 2nd Factor (U2F) CTAP1 HOTP (Event) TOTP (Time) Smartcard (PIV-compatible) OpenSC-compatible Enterprise
		PK2000IA0000E-2002-2BA-SBB <i>(Delivery in single packaging)</i>	





	iShield Key 2 FIDO2 Enterprise	PK2000IC0000E-2002-2AA-SBT <i>(Delivery in tray)</i>	WebAuthn, FIDO2/CTAP2 Universal 2nd Factor (U2F) CTAP1 Enterprise
		PK2000IC0000E-2002-2AA-SBB <i>(Delivery in single packaging)</i>	
	iShield Key 2 Pro Enterprise	PK2000IC0000E-2002-2BA-SBT <i>(Delivery in tray)</i>	WebAuthn, FIDO2/CTAP2 Universal 2nd Factor (U2F) CTAP1 HOTP (Event) TOTP (Time) Smartcard (PIV-compatible) OpenSC-compatible Enterprise
		PK2000IC0000E-2002-2BA-SBB <i>(Delivery in single packaging)</i>	



Product Type	Product Series	Part Number	Supported Standards / Features
	iShield Key 2 FIDO2 MIFARE Enterprise	PK2000IA0000E-2002-2AB-SBT <i>(Delivery in tray)</i>	WebAuthn, FIDO2/CTAP2 Universal 2nd Factor (U2F) CTAP1 MIFARE DESFire EV3 Enterprise
		PK2000IA0000E-2002-2AB-SBB <i>(Delivery in single packaging)</i>	
	iShield Key 2 Pro MIFARE Enterprise	PK2000IA0000E-2002-2BB-SBT <i>(Delivery in tray)</i>	WebAuthn, FIDO2/CTAP2 Universal 2nd Factor (U2F) CTAP1 HOTP (Event) TOTP (Time) Smartcard (PIV-compatible) OpenSC-compatible MIFARE DESFire EV3 Enterprise
		PK2000IA0000E-2002-2BB-SBB <i>(Delivery in single packaging)</i>	



	USB-C NFC	iShield Key 2 FIDO2 MIFARE Enterprise	PK2000IC0000E-2002-2AB-SBT <i>(Delivery in tray)</i>	WebAuthn, FIDO2/CTAP2 Universal 2nd Factor (U2F) CTAP1 MIFARE DESFire EV3 Enterprise
			PK2000IC0000E-2002-2AB-SBB <i>(Delivery in single packaging)</i>	
	USB-C NFC	iShield Key 2 Pro MIFARE Enterprise	PK2000IA0000E-2002-2BB-SBT <i>(Delivery in tray)</i>	WebAuthn, FIDO2/CTAP2 Universal 2nd Factor (U2F) CTAP1 HOTP (Event) TOTP (Time) Smartcard (PIV-compatible) OpenSC-compatible MIFARE DESFire EV3 Enterprise
			PK2000IC0000E-2002-2BB-SBB <i>(Delivery in single packaging)</i>	



Product Type	Product Series	Part Number	Supported Standards / Features
	USB-A NFC	iShield Key 2 FIDO2 FIPS Enterprise	WebAuthn, FIDO2/CTAP2 Universal 2nd Factor (U2F) CTAP1 FIPS140-3 Level 3 Enterprise
		PK2000IA0000E-2002-2DA-SBT <i>(Delivery in tray)</i>	
	USB-A NFC	iShield Key 2 Pro FIPS Enterprise	WebAuthn, FIDO2/CTAP2 Universal 2nd Factor (U2F) CTAP1 HOTP (Event) TOTP (Time) Smartcard (PIV-compatible) OpenSC-compatible FIPS140-3 Level 3 Enterprise
		PK2000IA0000E-2002-2DA-SBB <i>(Delivery in single packaging)</i>	

	USB-C NFC	iShield Key 2 FIDO2 FIPS Enterprise	PK2000IC0000E-2002-2DA-SBT <i>(Delivery in tray)</i>	WebAuthn, FIDO2/CTAP2 Universal 2nd Factor (U2F) CTAP1 FIPS140-3 Level 3 Enterprise
			PK2000IC0000E-2002-2DA-SBB <i>(Delivery in single packaging)</i>	
	USB-C NFC	iShield Key 2 Pro FIPS Enterprise	PK2000IC0000E-2002-2CA-SBT <i>(Delivery in tray)</i>	WebAuthn, FIDO2/CTAP2 Universal 2nd Factor (U2F) CTAP1 HOTP (Event) TOTP (Time) Smartcard (PIV-compatible) OpenSC-compatible FIPS140-3 Level 3 Enterprise
			PK2000IC0000E-2002-2CA-SBB <i>(Delivery in single packaging)</i>	

Product Type		Product Series	Part Number	Supported Standards / Features
	USB-A NFC	iShield Key 2 FIDO2 HID Enterprise	PK2000IA0000E-2002-2AD-SBT <i>(Delivery in tray)</i>	WebAuthn, FIDO2/CTAP2 Universal 2nd Factor (U2F) CTAP1 HID SEOS Enterprise
			PK2000IA0000E-2002-2AD-SBB <i>(Delivery in single packaging)</i>	
	USB-A NFC	iShield Key 2 Pro HID Enterprise	PK2000IC0000E-2002-2BD-SBT <i>(Delivery in tray)</i>	WebAuthn, FIDO2/CTAP2 Universal 2nd Factor (U2F) CTAP1 HOTP (Event) TOTP (Time) Smartcard (PIV-compatible) OpenSC-compatible HID SEOS Enterprise
			PK2000IC0000E-2002-2BD-SBB <i>(Delivery in single packaging)</i>	
	USB-C NFC	iShield Key 2 FIDO2 HID Enterprise	PK2000IA0000E-2002-2AD-SBT <i>(Delivery in tray)</i>	WebAuthn, FIDO2/CTAP2 Universal 2nd Factor (U2F) CTAP1 HID SEOS Enterprise
			PK2000IA0000E-2002-2AD-SBB <i>(Delivery in single packaging)</i>	
	USB-C NFC	iShield Key 2 Pro HID Enterprise	PK2000IC0000E-2002-2BD-SBT <i>(Delivery in tray)</i>	WebAuthn, FIDO2/CTAP2 Universal 2nd Factor (U2F) CTAP1 HOTP (Event) TOTP (Time) Smartcard (PIV-compatible) OpenSC-compatible HID SEOS Enterprise
			PK2000IC0000E-2002-2BD-SBB <i>(Delivery in single packaging)</i>	

Product Type	Product Series	Part Number	Supported Standards / Features
	USB-A NFC	PK2000IA0000E-2002-2AD-SBT <i>(Delivery in tray)</i>	WebAuthn, FIDO2/CTAP2 Universal 2nd Factor (U2F) CTAP1 FIPS140-3 Level 3 HID SEOS Enterprise
		PK2000IA0000E-2002-2AD-SBB <i>(Delivery in single packaging)</i>	
	USB-A NFC	PK2000IA0000E-2002-2BD-SBT <i>(Delivery in tray)</i>	WebAuthn, FIDO2/CTAP2 Universal 2nd Factor (U2F) CTAP1 HOTP (Event) TOTP (Time) Smartcard (PIV-compatible) OpenSC-compatible FIPS140-3 Level 3 HID SEOS Enterprise
		PK2000IA0000E-2002-2BD-SBB <i>(Delivery in single packaging)</i>	

	USB-C NFC	PK2000IC0000E-2002-2DD-SBT <i>(Delivery in tray)</i>	WebAuthn, FIDO2/CTAP2 Universal 2nd Factor (U2F) CTAP1 FIPS140-3 Level 3 HID SEOS Enterprise
		PK2000IC0000E-2002-2DD-SBB <i>(Delivery in single packaging)</i>	
	USB-C NFC	PK2000IC0000E-2002-2CD-SBT <i>(Delivery in tray)</i>	WebAuthn, FIDO2/CTAP2 Universal 2nd Factor (U2F) CTAP1 HOTP (Event) TOTP (Time) Smartcard (PIV-compatible) OpenSC-compatible FIPS140-3 Level 3 HID SEOS Enterprise
		PK2000IC0000E-2002-2CD-SBB <i>(Delivery in single packaging)</i>	

Product Type	Product Series	Part Number	Supported Standards / Features
	USB-A NFC	PK2000IA0000E-2002-2AC-SBT <i>(Delivery in tray)</i>	WebAuthn, FIDO2/CTAP2 Universal 2nd Factor (U2F) CTAP1 LEGIC advant/neon Enterprise
		PK2000IA0000E-2002-2AC-SBB <i>(Delivery in single packaging)</i>	
	USB-A NFC	PK2000IA0000E-2002-2BC-SBT <i>(Delivery in tray)</i>	WebAuthn, FIDO2/CTAP2 Universal 2nd Factor (U2F) CTAP1 HOTP (Event) TOTP (Time) Smartcard (PIV-compatible) OpenSC-compatible LEGIC advant/neon Enterprise
		PK2000IA0000E-2002-2BC-SBB <i>(Delivery in single packaging)</i>	

	USB-C NFC	iShield Key 2 FIDO2 LEGIC Enterprise	PK2000IA0000E-2002-2AC-SBT <i>(Delivery in tray)</i>	WebAuthn, FIDO2/CTAP2 Universal 2nd Factor (U2F) CTAP1 LEGIC advant/neon Enterprise
			PK2000IA0000E-2002-2AC-SBB <i>(Delivery in single packaging)</i>	
	USB-C NFC	iShield Key 2 Pro LEGIC Enterprise	PK2000IC0000E-2002-1BC-SBT <i>(Delivery in tray)</i>	WebAuthn, FIDO2/CTAP2 Universal 2nd Factor (U2F) CTAP1 HOTP (Event) TOTP (Time) Smartcard (PIV-compatible) OpenSC-compatible LEGIC advant/neon Enterprise
			PK2000IC0000E-2002-1BC-SBB <i>(Delivery in single packaging)</i>	

Product Type	Product Series	Part Number	Supported Standards / Features	
	USB-A NFC	iShield Key 2 FIDO2 FIPS LEGIC Enterprise	PK2000IA0000E-2002-2DC-SBT <i>(Delivery in tray)</i>	WebAuthn, FIDO2/CTAP2 Universal 2nd Factor (U2F) CTAP1 FIPS140-3 Level 3 LEGIC advant/neon Enterprise
			PK2000IA0000E-2002-2DC-SBB <i>(Delivery in single packaging)</i>	
	USB-A NFC	iShield Key 2 Pro FIPS LEGIC Enterprise	PK2000IA0000E-2002-2CC-SBT <i>(Delivery in tray)</i>	WebAuthn, FIDO2/CTAP2 Universal 2nd Factor (U2F) CTAP1 HOTP (Event) TOTP (Time) Smartcard (PIV-compatible) OpenSC-compatible FIPS140-3 Level 3 LEGIC advant/neon Enterprise
			PK2000IA0000E-2002-2CC-SBB <i>(Delivery in single packaging)</i>	

	USB-C NFC	iShield Key 2 FIDO2 FIPS LEGIC Enterprise	PK2000IC0000E-2002-2DC-SBT <i>(Delivery in tray)</i>	WebAuthn, FIDO2/CTAP2 Universal 2nd Factor (U2F) CTAP1 FIPS140-3 Level 3 LEGIC advant/neon Enterprise
			PK2000IC0000E-2002-2DC-SBB <i>(Delivery in single packaging)</i>	
	USB-C NFC	iShield Key 2 Pro FIPS LEGIC Enterprise	PK2000IC0000E-2002-2CC-SBT <i>(Delivery in tray)</i>	WebAuthn, FIDO2/CTAP2 Universal 2nd Factor (U2F) CTAP1 HOTP (Event) TOTP (Time) Smartcard (PIV-compatible) OpenSC-compatible FIPS140-3 Level 3 LEGIC advant/neon Enterprise

4. Product Description

iShield Key 2.0 is a FIDO Security Key with following features:

- Interfaces: USB-A/USB-C and NFC
- Supports FIDO2 (CTAP2.1) with Enterprise Attestation and FIDO U2F
- Storage of up to 300 passkeys
- Touch authentication via USB
- Tap-and-go authentication with NFC (e.g. on mobile devices)
- OS: Windows 10/11, MacOS, iOS, iPadOS, Linux, Chrome OS, Android
- Browser: Firefox, MS Edge, Google Chrome, Apple Safari
- HOTP, TOTP, static password with 42 slots and 2 can be assigned to touch presses (long and short press)
- MIFARE DESFire EV3
- HID SEOS
- LEGIC advent/neon
- Firmware and applications can be remotely updated

4.1 Current Consumption

The drive-level current consumption as a function of operating mode is shown in Table 2.

Table 2: Current Consumption

Interface	Initialization	Idle	Unit
USB 2.0	30	19.5	mA

4.2 Environmental Specifications

4.2.1 Recommended Operating Conditions

The recommended operating conditions for the iShield Key Series are provided in Table 3.

Table 3: Recommended Operating Conditions¹

Parameter	Value
Extended Operating Temperature	-25 °C to 70 °C
Power Supply V _{CC} Voltage	5,0 V ± 10%

4.2.2 Recommended Storage Conditions

The recommended storage conditions are listed in Table 4.

Table 4: Recommended Storage Conditions

Parameter	Value
Extended Storage Temperature	-25 °C to 85 °C

4.2.3 Shock, Vibration and Humidity

The maximum shock, vibration and humidity conditions are listed in Table 5.

Table 5: Shock, Vibration and Humidity

Parameter	Value
Non-Operating Shock	1,500 g, 0,5 ms pulse duration, half-sine wave (IEC 60068-2-27, JESD22-B110)
Non-Operating Vibration	50 g, 10Hz – 2000Hz, 3 axes (IEC 60068-2-6,
Humidity (Non-Condensing)	85% RH 85 °C, 330 hrs, max. supply voltage (JESD22-A101)

¹ Adequate airflow is required to ensure the temperature.

4.3 Regulatory Compliance

The iShield Key Series USB-A / C with NFC comply with the regulations / standards listed in Table 6.

Table 6: Regulatory Compliance

Regulation/ Standard	Description
EMC	CE – 2014/30/EU FCC – 47 CFR Part 15 UKCA – S.I. 2016 No. 1091 and S.I. 2012 No. 3032
RoHS	2011/65/EU with 2015/863/EU and 2017/2102/EU
REACH	1907/2006/EU and 207/2011/EU
WEEE	2012/19/EU
FDA	Food and Drug Administration
TAA	Trade Agreements Act (TAA)
MIL-STD810H	DoD test method standard
MIL STD-1009	Salt atmosphere testing
JESD22-A104	Temperature cycling testing
JESD22-A103	High temperature storage life
JESD22-A108	Temperature, Bias, Operating Life
AEC Q100-008	Early Life Failure Rate
JESD22-A102D	Accelerate Moisture Resistance
IEC 60068-2-11	Test method for assessing the corrosion resistance
IEC 60068-2-27	Non-repetitive or repetitive shocking
JESD22-B110	Mechanical shock
IEC 60068-2-6	Environmental testing: Vibration
JESD22-A108	Temperature, bias and operating life
IEC 61000-4-2	ESD testing
DIN ISO 9022-9	Optics and photonics

4.4 Mechanical Specifications

Physical dimensions are detailed in Table 7. Figure 3 illustrates the iShield Key dimensions.

Table 7: Physical Dimensions

Physical Dimensions			
	USB-A	USB-C	Unit
Length	54.6 ±0.2	50.9 ±0.2	mm
Width	16.00 ±0.2	16.00 ±0.2	
Thickness (Max)	5.2 ±0.2	5.2 ±0.2	
Weight (Max Capacity)	5	5	g

4.5 Reliability

FIT and MTBF calculation

The Mean Time Between Failures (MTBF) for the Swissbit® iShield Key Hardware Authenticator is specified to exceed the value listed in the following Table 8.

Table 8: MTBF

Parameter	Value
MTBF (at 25 °C)	> 4,000,000 hours

5. Electrical Interface

The signal/pin assignments and descriptions for USB2 Type-A are listed in Table 9.

Figure 1: USB2 Type-A connector pinout

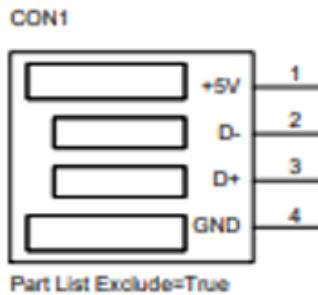
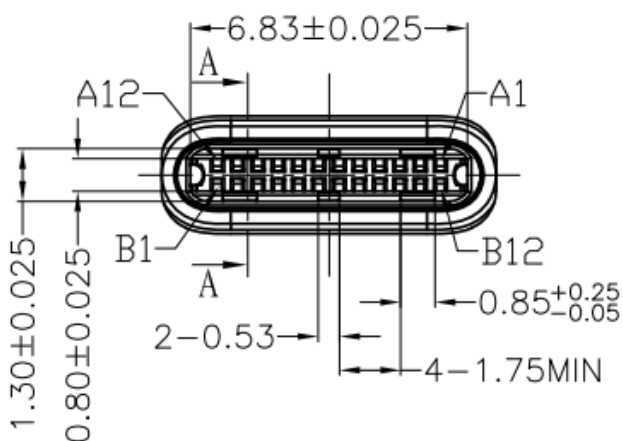

Table 9: Pin Assignment, Name and Description

Pin	Signal Name	Description
1	V_Bus	Operating voltage
2	D-	Data signal pair
3	D+	Data signal pair
4	GND	Power Ground

The signal/pin assignments and descriptions for USB2 Type-C are listed in Table 9.

Figure 2: USB2 Type-C connector pinout



PIN ASSIGNMENT(REF.)

A12	A11	A10	A9	A8	A7	A6	A5	A4	A3	A2	A1
GND	RX2+	RX2-	VBUS	SBU1	D-	D+	CC	VBUS	TX1-	TX1+	GND
GND	TX2+	TX2-	VBUS	VCONN			SBU2	VBUS	RX1-	RX1+	GND
B1	B2	B3	B4	B5	B6	B7	B8	B9	B10	B11	B12

6. Electrical Specification

Table 10: Absolute Maximum Ratings

Parameter	Symbol	Min	Max	Unit
Power Supply Voltage	V_Bus	-0.5	6.0	V
Voltage at D+ and D-	V_Data	-0.5	5.0	

7. Package Mechanical

Figure 3: iShield Key USB-A / NFC

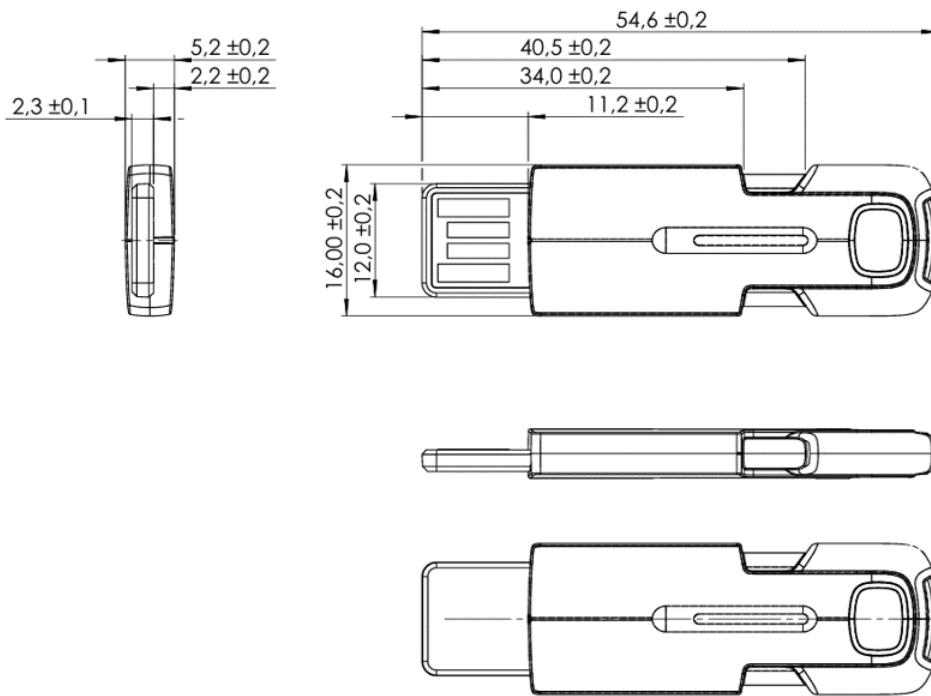
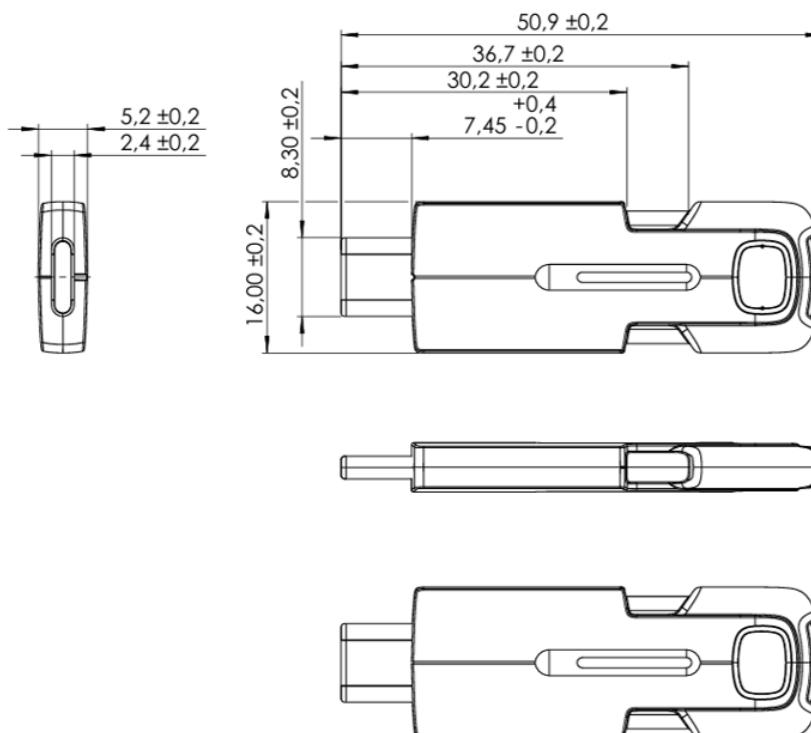

Figure 4: iShield Key USB-C / NFC



8. Functionality

See the following Table 11 for a list of functionality.

Table 11: Function

Function	Value
Communication interface	USB-A/C, NFC
Supported Standards (<i>available in iShield Key Pro</i>)	HOTP / TOTP / PIV / U2F / FIDO2 (CTAP 2.1)
Protocols	Mifare DESFire EV3, LEGIC advent/neon, HID SEOS

9. Features

See the following Table 11 for a list of features.

Table 12: Function

Function	Interface	Value
FIDO2	USB / NFC	U2F / FIDO2 (CTAP 2.1)
PIV	USB / NFC	PIV / OpenSC
Passcode	USB / NFC	TOTP / HOTP / PASSWORD
MIFARE	NFC	DESFire EV3
HID	NFC	SEOS
LEGIC	NFC	advant / neon

10. Part Number Decoder

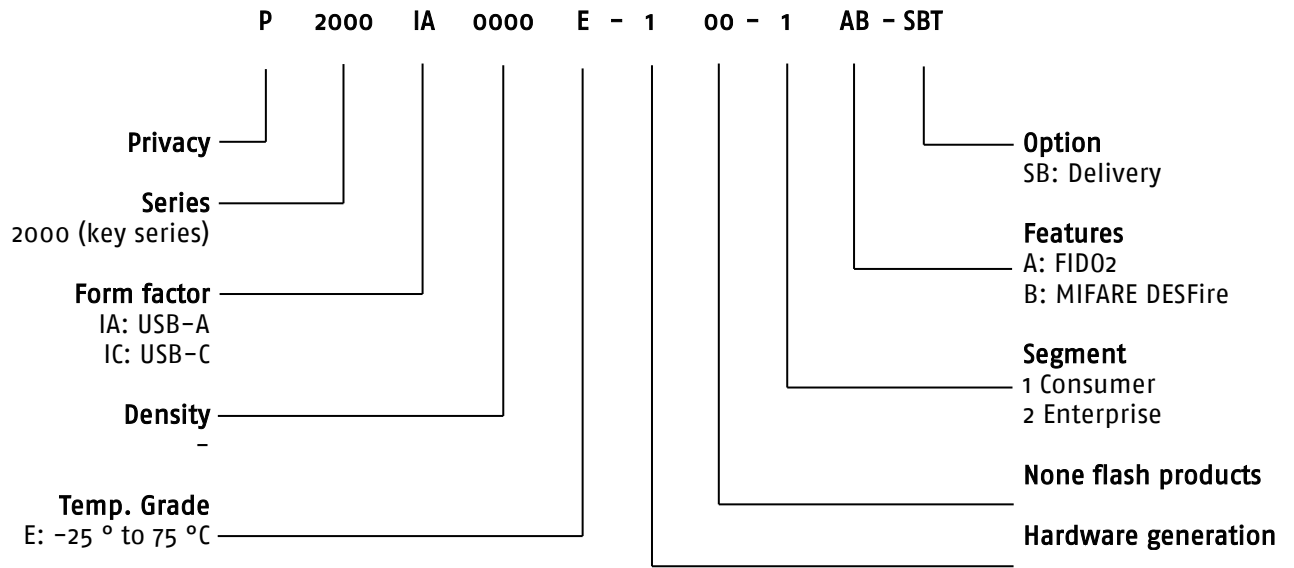



10.1 Delivery

Delivery in single packaging	SBB
Delivery in tray	SBT

11. Marking Specification

Figure 5: iShield Key 2 Series

<p>Lasermarking (front side)</p>	<p>Swissbit iShield Key 2 Series with secured by SB Logo</p>														
	<p>iShield Key 2</p> <p>Secured by Swissbit Logo color "white"</p>														
<p>Lasermarking (rear side)</p>	<p>Swissbit iShield Key 2 Series QR-Code, Serial Number, Feature Identifier</p>														
	<p>iShield Key 2 Series</p> <p>QR code Serial Number</p> <p>Human Readable Serial Number</p> <p>Feature Identifier</p> <table border="1" data-bbox="1109 1108 1380 1332"> <thead> <tr> <th>Feature</th> <th>Marking</th> </tr> </thead> <tbody> <tr> <td>FIPS</td> <td>F</td> </tr> <tr> <td>Pro</td> <td>P</td> </tr> <tr> <td>MIFARE</td> <td>M</td> </tr> <tr> <td>HID</td> <td>H</td> </tr> <tr> <td>Legic</td> <td>L</td> </tr> <tr> <td>Enterprise</td> <td>E</td> </tr> </tbody> </table>	Feature	Marking	FIPS	F	Pro	P	MIFARE	M	HID	H	Legic	L	Enterprise	E
Feature	Marking														
FIPS	F														
Pro	P														
MIFARE	M														
HID	H														
Legic	L														
Enterprise	E														

12. Revision History

Table 13: Document Revision History

Date	Revision	Description	Revision Details
10.04.2025	1.00	Initial release	

Disclaimer:

No part of this document may be copied or reproduced in any form or by any means, or transferred to any third party, without the prior written consent of an authorized representative of Swissbit AG ("SWISSBIT"). The information in this document is subject to change without notice. SWISSBIT assumes no responsibility for any errors or omissions that may appear in this document and disclaims responsibility for any consequences resulting from the use of the information set forth herein. SWISSBIT makes no commitments to update or to keep current information contained in this document. The products listed in this document are not suitable for use in applications such as, but not limited to, aircraft control systems, aerospace equipment, submarine cables, nuclear reactor control systems and life support systems. Moreover, SWISSBIT does not recommend or approve the use of any of its products in life support devices or systems or in any application where failure could result in injury or death. If a customer wishes to use SWISSBIT products in applications not intended by SWISSBIT, said customer must contact an authorized SWISSBIT representative to determine SWISSBIT willingness to support a given application. The information set forth in this document does not convey any license under the copyrights, patent rights, trademarks or other intellectual property rights claimed and owned by SWISSBIT. The information set forth in this document is considered to be "Proprietary" and "Confidential" property owned by SWISSBIT.

ALL PRODUCTS SOLD BY SWISSBIT ARE COVERED BY THE PROVISIONS APPEARING IN SWISSBIT'S TERMS AND CONDITIONS OF SALE ONLY, INCLUDING THE LIMITATIONS OF LIABILITY, WARRANTY AND INFRINGEMENT PROVISIONS. SWISSBIT MAKES NO WARRANTIES OF ANY KIND, EXPRESS, STATUTORY, IMPLIED OR OTHERWISE, REGARDING INFORMATION SET FORTH HEREIN OR REGARDING THE FREEDOM OF THE DESCRIBED PRODUCTS FROM INTELLECTUAL PROPERTY INFRINGEMENT AND EXPRESSLY DISCLAIMS ANY SUCH WARRANTIES INCLUDING WITHOUT LIMITATION ANY EXPRESS, STATUTORY OR IMPLIED WARRANTIES OF MERCHANTABILITY OR FITNESS FOR A PARTICULAR PURPOSE.

© 2025 SWISSBIT AG All rights reserved.